

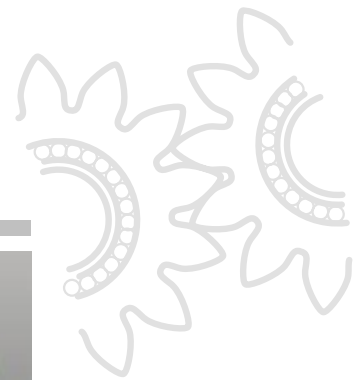

# Flow- Measurement Technology

## VHM series

- ▶ Paints, Dyes
- ▶ Chemicals
- ▶ Pharmaceuticals
- ▶ Two-component mixers
- ▶ Petrochemicals



## VHM gear flow meter

- ▶ Were developed for high precision flow metering for a wide variety of liquids, especially liquids with high abrasiveness and poor lubricity.
- ▶ Applications include: chemical, petrochemical, pharmaceutical and cosmetic industry, two-component mixers, paints, aviation.
- ▶ Are dead spaced optimized for (easy flushing) use in the paint industry and for paint spraying systems.
- ▶ Are positive displacement units based on the meshing gear principle. Each tooth generates an impulse by recognition of the gear rotation by a non-contact detection system according to the carrier frequency principle.
- ▶ Are available with single, double or quadruple resolution, signal-output with NPN or PNP switching mode.
- ▶ Signal pick-ups with **Ex-certification** (Ex ia IIC T6...T4) and signal pick-ups with a fibre optic output are applicable for hazardous locations.

## Technical Data

Type	Flow Range		K-Faktor Imp./l		Calculation Factors	
	l/min	GPM	Impulses/l	Impulses/Gal.		
VHM 01	.01.....1	.003.....264	ca. 30 000	ca. 113 563.2	1 litre	△ 0.26417 U.S. Gallon
VHM 02 - 1	.05.....2	.013.....528	ca. 8 800	ca. 33 311.872	1 U.S. Gallon	△ 3.78544 litre
VHM 02 - 2	.10.....4	.026.....1.056	ca. 4 400	ca. 16 655.936	1 bar	△ 14.503684 psi
VHM 02 - 3	.40.....8	.106.....2.113	ca. 2 200	ca. 8 327.968	1 psi	△ 0.068948 bar
VHM 03 - 2	.50.....20(30)	.132..5.283 (7.925)	ca. 1 000	ca. 3 785.44	psi	= pound-weight per square inch
					GPM	= U.S. Gallon per minute

**K-Faktor:** see calibration-certificate for precise data

**(30) and (7.925):** with a single channel flow sensor only

Materials		Accuracy	+/- 0,5%	viscosity > 10mm <sup>2</sup> /s
Body	Stainless Steel 316		+/- 1%	viscosity 1-10mm <sup>2</sup> /s
Gears	Stainless Steel 316	Repeatability	+/- 0,5‰	under same operating conditions
Bearings	Tungsten Carbide	Max. Operating Pressure	250 bar	3625 psi
Seals	FEP-FKM (Standard) NBR (upon request) PTFE (upon request)	Medium Temperature	-20°....120°C	-4°....248°F
K-Faktor	see calibration-certificate for precise data	Viscosity Range	1-20.000mm <sup>2</sup> /s	
		Mounting Positions	free selectable	

▶ **Special designs and materials on request**

▶ The installation into the pipe line can be made by means of a mounting plate or manifold.

▶ **General Principle of Functioning see Page 15**

## Applications

<b>Chemical Industry</b>	→	continuous dosing
<b>Pharmaceutical Industry</b>	→	mixing, batching
<b>Cosmetic Industry</b>	→	dosing, batching
<b>Dyes and Paints</b>	→	flow control, consumption monitoring
<b>2-component mixers</b>	→	monitoring, regulation of mixing ratio

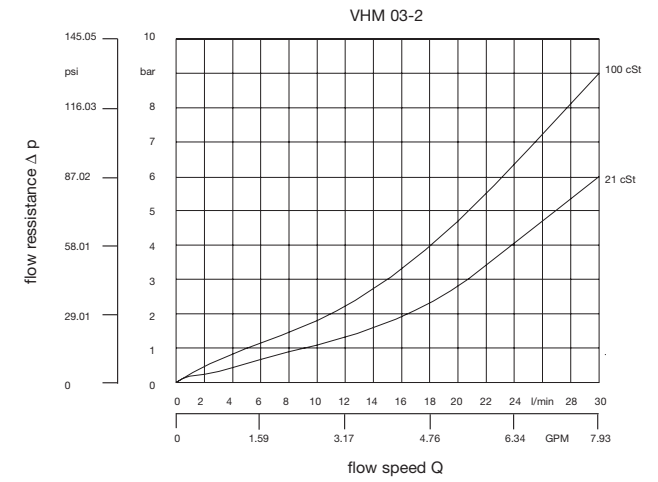
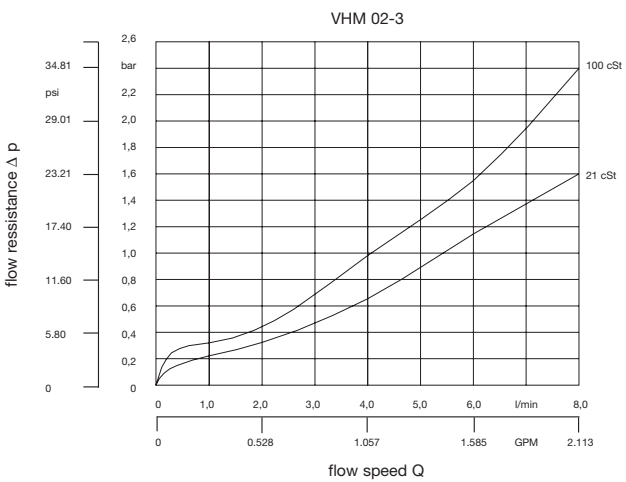
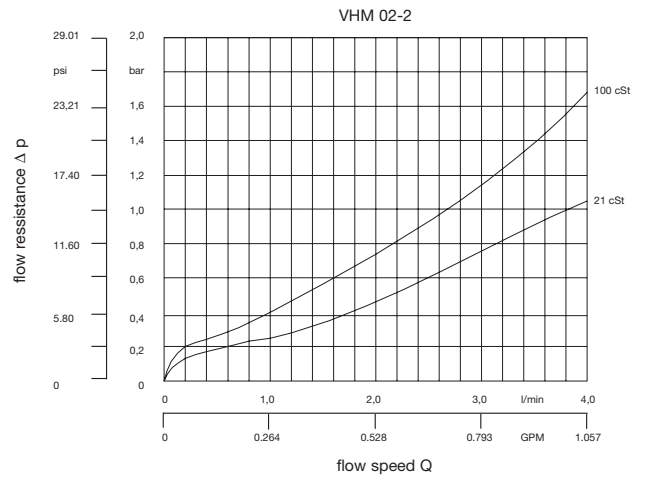
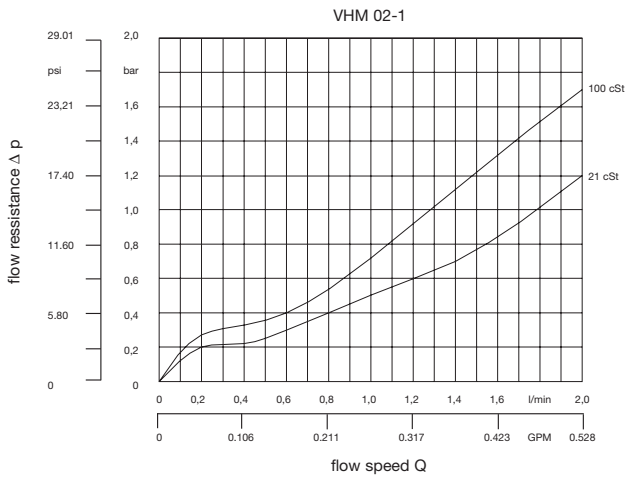
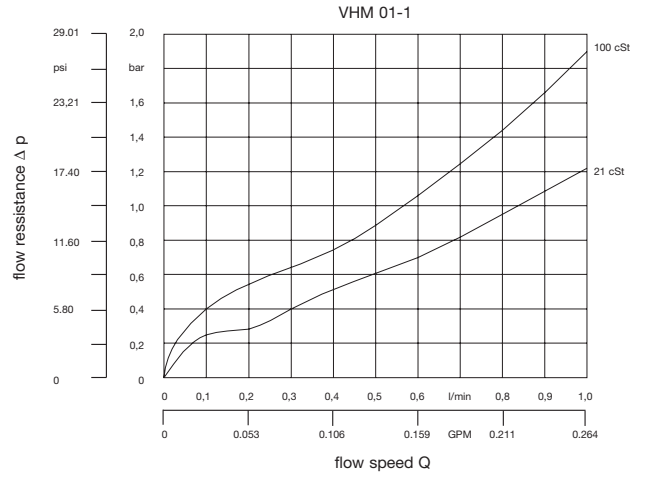

## Flow Meter-Dimensions

► **VHM 01/02** View X

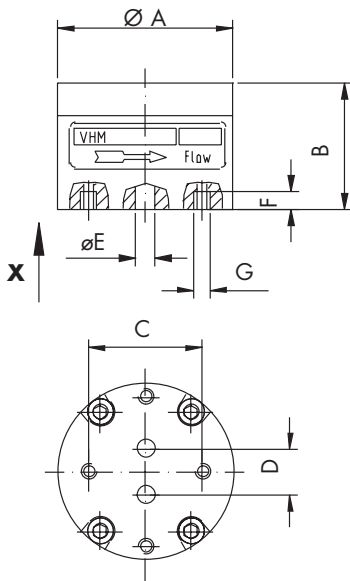

► **VHM 03** View Y

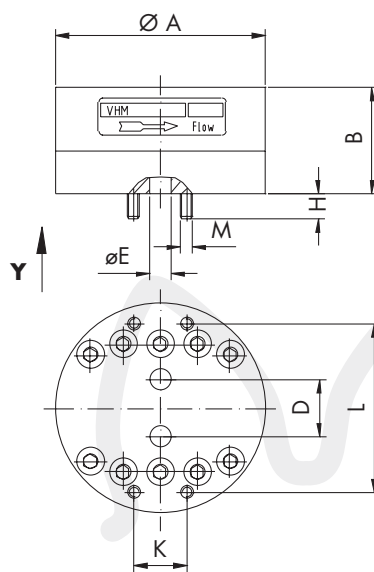

## Flow Meter-Dimensions

Type	A	B	C	D	E	F	G	K	L	M	H	Weight
VHM 01 - 1	Ø 68	29	44	12	Ø 4	6	M6					0,760 kg
VHM 02 - 1	Ø 68	29	44	18	Ø 6	6	M6					0,740 kg
VHM 02 - 2	Ø 68	34	44	18	Ø 6	6	M6					0,860 kg
VHM 02 - 3	Ø 68	43	44	18	Ø 6	6	M6					1,075 kg
VHM 03 - 2	Ø 99	50		27	Ø 10			25	81	M6	12	2,700 kg

► **Special designs on request**

▶ AHM 1/2 - .S... Side ports

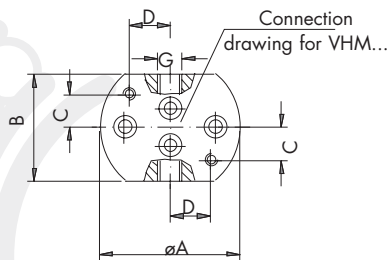
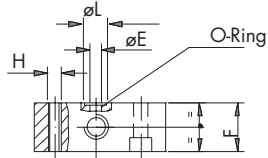

▶ AHM 3 - .S... Side ports

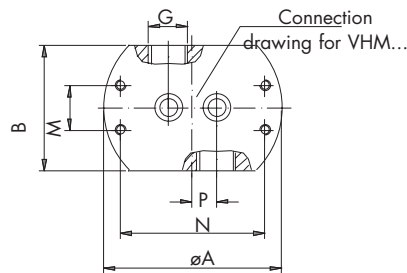
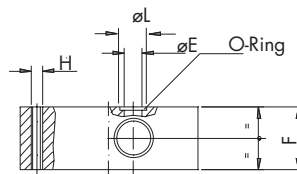

▶ Side port connection

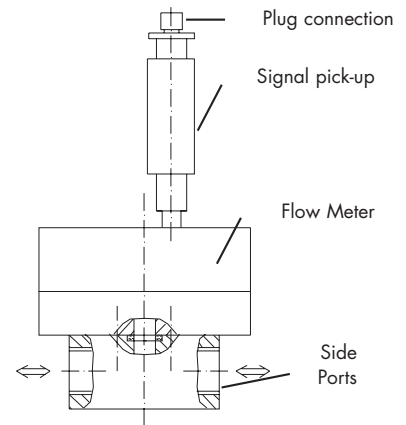

Subplates-Dimensions Side Port Connection

Line no.	Type	Ø A	B	C	D	M	N	Ø E	G	F	H	P	O-Ring
1	AHM01-.SAN/.	68	52	16	20	-	-	4	G 1/8"	24	M 6	-	6.07 x 1.78
2	AHM01-.SBN/.	68	52	16	20	-	-	4	G 1/4"	24	M 6	-	6.07 x 1.78
3	AHM01-.SCN/.	68	52	16	20	-	-	4	G 3/8"	35	M 6	-	6.07 x 1.78
4	AHM01-.SFN/.	68	52	16	20	-	-	4	1/8"NPT	24	M 6	-	6.07 x 1.78
5	AHM01-.SGN/.	68	52	16	20	-	-	4	1/4"NPT	24	M 6	-	6.07 x 1.78
6	AHM01-.SHN/.	68	52	16	20	-	-	4	3/8"NPT	35	M 6	-	6.07 x 1.78
7	AHM02-.SAN/.	68	52	16	20	-	-	6	G 1/8"	24	M 6	-	7.65 x 1.78
8	AHM02-.SBN/.	68	52	16	20	-	-	6	G 1/4"	24	M 6	-	7.65 x 1.78
9	AHM02-.SCN/.	68	52	16	20	-	-	6	G 3/8"	35	M 6	-	7.65 x 1.78
10	AHM02-.SFN/.	68	52	16	20	-	-	6	1/8"NPT	24	M 6	-	7.65 x 1.78
11	AHM02-.SGN/.	68	52	16	20	-	-	6	1/4"NPT	24	M 6	-	7.65 x 1.78
12	AHM02-.SHN/.	68	52	16	20	-	-	6	3/8"NPT	35	M 6	-	7.65 x 1.78
13	AHM03-.SCN/.	100	70	-	-	25	81	10	G 3/8"	35	M 6	13.5	12.42 x 1.78
14	AHM03-.SDN/.	100	70	-	-	25	81	10	G 1/2"	35	M 6	13.5	12.42 x 1.78
15	AHM03-.SHN/.	100	70	-	-	25	81	10	3/8"NPT	35	M 6	13.5	12.42 x 1.78
16	AHM03-.SIN/.	100	70	-	-	25	81	10	1/2"NPT	35	M 6	13.5	12.42 x 1.78

# Type Codes Flow Meter VHM + Subplates AHM

<b>V H M</b>	<b>Flow Meter VHM Size</b>	<input type="text" value="01"/>	<input type="text" value="02"/>	<input type="text" value="03"/>	
	<b>Measuring range</b>	<input type="text" value="1"/>	<input type="text" value="1"/> <input type="text" value="2"/> <input type="text" value="3"/>	<input type="text" value="2"/>	
		0.01 – 1 l/min 0.003 – 0.264 GPM	0.05 – 2 l/min 0.013 – 0.528 GPM	0.1 – 4 l/min 0.026 – 1.056 GPM	0.4 – 8 l/min 0.106 – 2.113 GPM
	<b>Backlash (works-determined)</b>	Reduced tolerance	= <input type="text" value="1"/>		
		Normal tolerance	= <input type="text" value="2"/>		
		Increased tolerance	= <input type="text" value="3"/>		
	<b>Housing material: stainless steel</b>	303 (upon request)	V 2 A	= <input type="text" value="2"/>	
		316 (Standard)	V 4 A	= <input type="text" value="4"/>	
	<b>Type of connection</b>	Subplate	= <input type="text" value="P"/>		
		Piping	= <input type="text" value="R"/>		
<b>Type of seal</b>	FEP-FKM (Standard)	= <input type="text" value="F"/>			
	NBR (upon request)	= <input type="text" value="N"/>			
	PTFE (upon request)	= <input type="text" value="T"/>			
<b>Series</b>	Works-determined $\geq 1$	<input type="checkbox"/>			
<b>VHM mounting from top side on AHM (upon request)</b>	Only for flow meter size VHM01/VHM02	= <input type="text" value="Z"/>			

**VHM** . - . . . . / . . —

⊗ 30 l/min and 7.925 GPM with a single-channel pick-up only

**Short term explanation to type of seals:**

FEP = Perflour Ethylene Propylene encapsulated O-Ring

FKM = Flourcarbon Rubber (core compound)

NBR = pure Acryl-Nitrile Butadiene Rubber O-Ring

PTFE = pure Polytetraflour-Ethylene Rubber O-Ring

<b>A H M</b>	<b>Subplate AHM</b>	VHM size	AHM size	
	<b>Affiliated VHM flow meter size</b>	<input type="text" value="01"/>	→ <input type="text" value="01"/>	
		<input type="text" value="02"/>	→ <input type="text" value="02"/>	
		<input type="text" value="03"/>	→ <input type="text" value="03"/>	
	<b>Housing material: stainless steel</b>	303 (Standard)	V 2 A	= <input type="text" value="2"/>
		316 (upon request)	V 4 A	= <input type="text" value="4"/>
	<b>Connection orientation</b>	Side connection	= <input type="text" value="S"/>	
		Bottom connection	= <input type="text" value="U"/>	
	<b>Type of connection (other types on request)</b>	G <sup>1/8"</sup>	= <input type="text" value="A"/>	G <sup>1/4"</sup> = <input type="text" value="B"/>
		G <sup>3/8"</sup>	= <input type="text" value="C"/>	G <sup>1/2"</sup> = <input type="text" value="D"/>
1/8" NPT		= <input type="text" value="F"/>	1/4" NPT = <input type="text" value="G"/>	
3/8" NPT		= <input type="text" value="H"/>	1/2" NPT = <input type="text" value="I"/>	
<b>Design</b>	Standard	= <input type="text" value="N"/>		
	Special	= <input type="text" value="S"/>		
<b>Series</b>	Works-determined $\geq 1$	<input type="checkbox"/>		
<b>VHM mounting from top side on AHM (upon request)</b>	Only for flow meter size VHM01/VHM02	= <input type="text" value="Z"/>		

**AHM** . - . . . . / . .

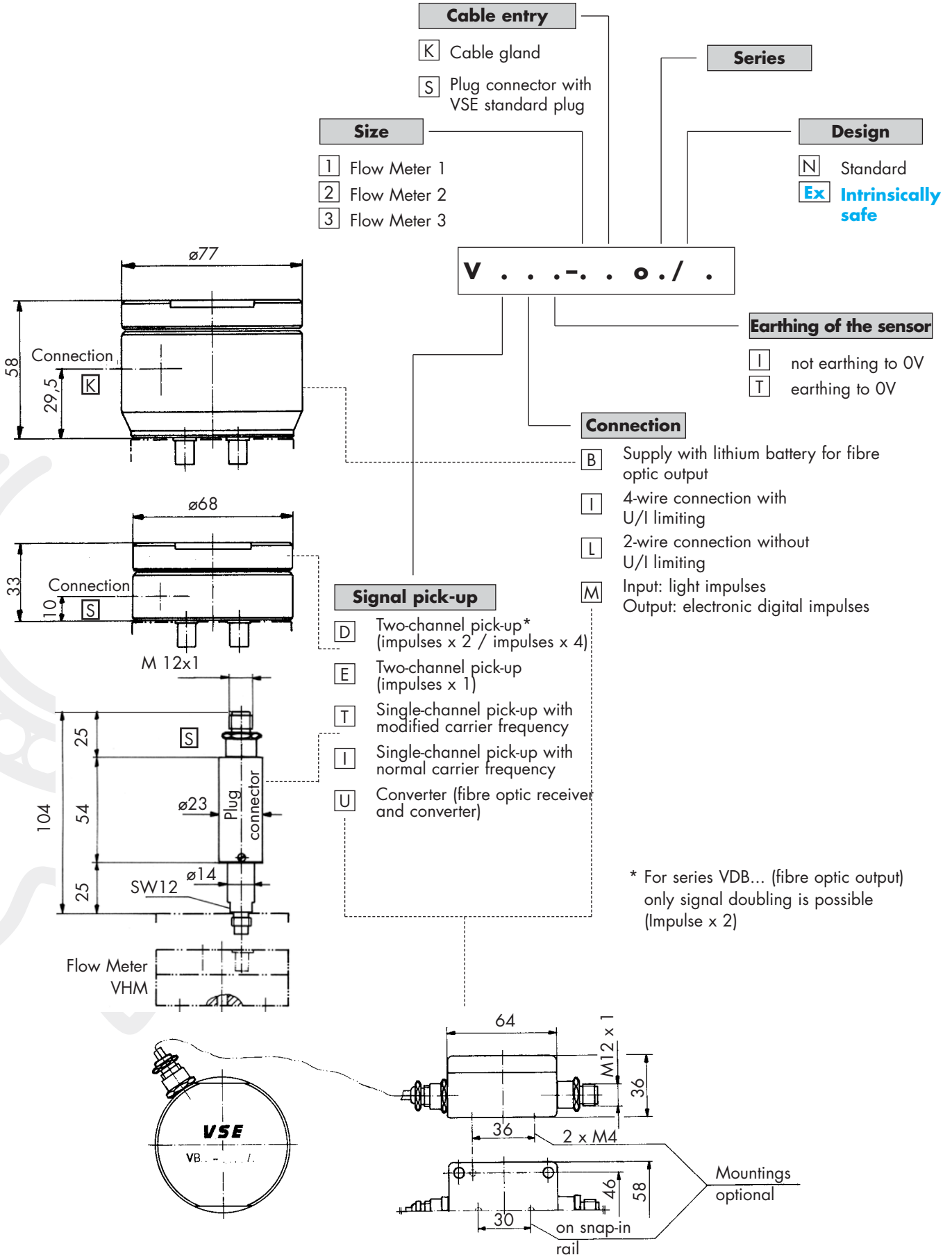

## Selection criteria - signal pick-ups

	Single pick-ups series VI.../VT...	Double pick-ups series VD.../VE...
General applications	in flow velocity measurement and volume measurement	in flow velocity measurement and volume measurement with high signal resolution
Measured volume signal resolution per conveyed tooth gap volum	1 impulse/measured volume	A. 2 impulses/measured volume or 4 impulses/measured volume optionally coded by jumpers in the pick-up B. 1 impulse/measured volume in modified series VE...
Galvanic isolation between the supply voltage and the signal output	NPN or PNP switching optocoupler outputs	NPN or PNP switching optocoupler output
When 2 single pick-ups are used in one flow meter body, the following possibilities arise	A. A high signal resolution and detection of the flow direction are possible with additional electronics. B. <b>Or</b> it is possible to implement a redundant system for increased safety in conjunction with the separate operation of both pick-ups. C. Separate power supply of the single pick-ups from galvanically isolated power supply units is possible.	
<b>EX design</b>	with intrinsic safety only in conjunction with VSE barrier amplifier. Ex designation EEx ia IIC T6...T4	with intrinsic safety only in conjunction with VSE barrier amplifier. Ex designation EEx ia IIC T6...T4

## VHM single pick-ups and double pick-ups in standard design

▶ The single pick-up operates with a carrier frequency oscillator which is modulated when a tooth passes. This modulation is detected by the amplifier and is used to generate one digital impulse per measured volume.

▶ The double pick-up operates with two independent carrier frequency oscillators which are modulated when a tooth passes. This modulation is detected by the amplifier and is used to generate 2 or 4 digital impulses per measured volume, which can be selected by the coding of the internal jumpers.

▶ Single and double pick-ups are equipped with an optocoupler transistor output which has a galvanic isolation between supply voltage and pick-up.

▶ This transistor output can be connected with the supply voltage of the pick-up as shown in the above connection diagrams or can be operated with a separate power supply. Depending on the polarity of the power supply to the transistor, either an PNP or a NPN switched output signal is generated.

▶ Output signal PNP switched

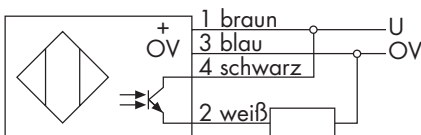

▶ Output signal NPN switched

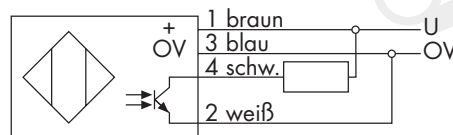



▶ The single pick-up operates with a carrier frequency oscillator which is modulated when a tooth passes.

The double pick-up operates with two independent carrier frequency oscillators which are modulated when a tooth passes.

▶ This modulation is detected by the amplifier and is used to generate a pulsing current signal in the supply current. The connected barrier amplifier detects the signal and generates a digital PNP signal for further processing.

The output impulses per measured volume correspond to those of the two standard designs.

▶ Single pick-ups and double pick-ups in Ex design are designed for intrinsic safety and may only be used in conjunction with the VSE barrier amplifier MK 13-P-Ex 0/24 V DC/K15.

▶ The flow meter with the single pick-up or double pick-up is located in the hazardous area. The barrier amplifier is installed outside the hazardous area in an electrical cabinet or terminal box (snap-in mounted on an installation rail DIN 50022).

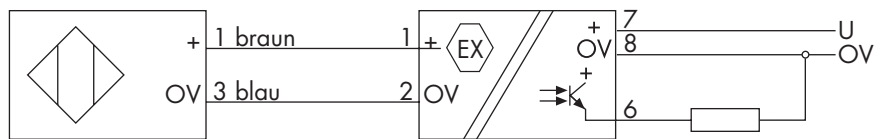

### Double pick-up with fibre optic output type VDB...

Applications under extremely difficult conditions	Applications	Measured volume signal resolution per conveyed tooth gap volume:	Battery operation with energy saving circuit
A) Environments with heavy electromagnetic interference. B) High voltage areas. C) <b>Rooms with explosion hazards</b> , e.g. spray painting equipment with electrostatic charge.	in flow velocity measurement and volume measurement with high signal resolution.	2 impulses/measured volume	2 years of operation without battery change.

▶ The double pick-up converts electrical impulses into light impulses and transmits these through a plastic optical fibre to the receiver, which is installed away from the extreme conditions. This converts the light impulses of the signal pick-up back into electrical impulses and outputs them to electronic evaluation devices for further processing. The output signal of the fibre optic receiver has a resolution of 2 impulses per measured volume with a pulse duty factor of 1 : 1.

▶ The signal frequency of the output impulses is proportional to the speed of rotation of the gearwheel and with the flow velocity and must be processed by the connected evaluating circuitry according to the values of the impulses.

▶ The output impulses of the fibre optic receiver can be either a pnp or an npn switched signal. The coding of the signals is easily possible and is performed on 2 separately programmable jumper bars in the receiver.

#### ▶ Double pick-up

with lithium battery

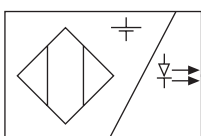

#### ▶ Fibre optic receiver

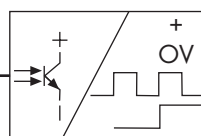

1 braun — U  
 3 blau — OV  
 2 weiß — Ausgangsimpuls  
 4 schwarz — Störungs Ausgang

## Signal pick-ups for VHM flow meters

<b>Technical Data Part 1</b>		<b>Single pick-ups in standard design</b>	<b>Double pick-ups in standard design</b>
		Deviations from EX design	Deviations from EX design
Signal pick-ups per flow meter		1 or 2	2 (1 active carrier frequency oscillator in Series VE*...)
Detection of direction of flow		Yes, by 2 signal pick-ups with a phase offset <sup>1</sup> of 90° mounted on one flow meter body	No
<b>Body data</b>			
Dimensions		Ø = 25 mm; length = 115 mm	Ø = 68 mm; length = 33 mm; overall length with sensor = 43 mm
Protection type		IP 54	IP 54
Material		Stainless steel	Anodized aluminium, coil holder stainless steel
Weight		100 g	165 g
Medium temperature		-4... +248°F / -20... +120 °C	-4... +185°F / -20... +85 °C
<i>Ex-design:</i>		-4... +140°F / -20... +60 °C T6 -4... +176°F / -20... +80 °C T5	-4... +140°F / -20... +60 °C T6 -4... +176°F / -20... +80 °C T5
Ambient temperature		-4... +140°F / -20... +60 °C	-4... +140°F / -20... +60 °C
<i>Ex-design:</i>		-4... +122°F / -20... +50 °C	-4... +122°F / -20... +50 °C
Ex approval		According to onformity certificate LCIE 02 ATEX 6136 X	According to onformity certificate LCIE 02 ATEX 6136 X
Ex designation		II 1G EEx ia IIC T6...T4	II 1G EEx ia IIC T6...T4
EX ignition suppression type in conjunction with specified VSE barrier amplifier		Intrinsically safe MK 13-P-Ex 0 / 24 VDC / K 15	Intrinsically safe MK 13-P-Ex 0 / 24 VDC / K 15
Supply voltage U <sub>DC</sub>		10-30 V <sub>DC</sub> , ► see data sheet Page 14	10-30 V <sub>DC</sub> , ► see data sheet Page 14
<b>VSE barrier amplifier</b>			
Installation site		Outside the Ex area in an electrical cabinet or terminal box. Mounted on installation rail DIN 50 022	Outside the Ex area in an electrical cabinet or terminal box. Mounted on installation rail DIN 50 022
Electrical connection		Intrinsically safe control line according to design specifications VDE 0165	Intrinsically safe control line according to design specifications VDE 0165
Supply Voltage U <sub>DC</sub>	Standard	7-30 V	7-30 V
	Ex design	5-9 V (by specified VSE barrier amplifier)	5-9 V (by specified VSE barrier amplifier)
Supply current I <sub>DC</sub>	Standard	3 mA max.	3 mA max.
	Ex design	<2,9 mA > 3,5 mA (modulated current signal)	<2,9 mA > 3,5 mA (modulated current signal)
<b>Connection general</b>	Standard	4-wire plug connection	4-wire plug connection
	Ex design	2-wire plug connection	2-wire plug connection
Plug with screened cable	Standard	4-pole standard plug, plug length=25mm, yellow cable	4-pole standard plug, plug length=25mm, yellow cable
	Ex design	4-pole standard plug, plug length=25mm, blue cable	4-pole standard plug, plug length=25mm, blue cable
Number of signal outputs		1 or 2 (when 2 single pick-ups are used in one flow meter body)	1 (the 2 signal pick-ups are evaluated by the internal amplifier and are connected to one output)
			1 in series VE...
Signal resolution per conveyed tooth gap volume (measurement volume V <sub>m</sub> )		1 impulse or 2 impulses by 2 single signal pick-ups with a phase offset of 90° and different carrier frequencies in one flow meter body	Optional 2 impulses (signal doubling) or 4 impulses (signal quadrupling) codable with internal jumpers
			1 impulse in series VE...

### <sup>1</sup>Explanation of series VT...

If detection of the direction of flow and a high signal resolution with additional external circuitry is necessary, 2 single pick-ups are used in one flow meter body, which are arranged with a mechanical offset of 90° with regard to the tooth flank sequence.

To prevent mutual interference between the 2 single pick-ups, these are selected with different carrier frequencies, i.e. one with a normal (VI...) and one with a modified (VT...) carrier frequency.

**\* Stock types, other types on request.**

Technical Data Part 2		Single pick-ups in standard design	Double pick-ups in standard design
		Deviations from Ex design	Deviations from Ex design
Signal output voltage $U_{DC}$	Standard	7-30 V (depending on the supply voltage and loading of the optocoupler)	7-30 V (depending on the supply voltage and loading of the optocoupler)
	Ex design	To VSE barrier amplifier: 7,5-27,5 V; depending on the supply voltage	To VSE barrier amplifier: 7,5-27,5 V; depending on the supply voltage
Output current $I_{DC}$	Standard	max. 10 mA (for supply voltage >16 VDC)	max. 10 mA (for supply voltage >16 VDC)
	Ex design	VSE barrier amplifier: output circuit <100 mA	VSE barrier amplifier: output circuit <100 mA
Signal switching frequency f		3 Hz-1,0 KHz	3 HZ-1,0 KHz
Signal output circuit	Standard	Optocoupler transistor with series resistance $R=1,2$ k Ohms Galvanic isolation from the supply voltage potential	Optocoupler transistor with series resistance $R=1,2$ k Ohms Galvanic isolation from the supply voltage potential
	Ex design	VSE barrier amplifier: output short-circuit resistant - see data sheet. Connection to the barrier amplifier supply voltage potential.	VSE barrier amplifier: output short-circuit resistant - see data sheet. Connection to the barrier amplifier supply voltage potential.
Signal switching polarity	Standard	Optional NPN or PNP selectable by external connections	Optional NPN or PNP selectable by external connections
	Ex design	PNP output signal via VSE barrier amplifier, i.e. connection to the barrier amplifier supply voltage potential	PNP output signal via VSE barrier amplifier, i.e. connection to the barrier amplifier supply voltage potential
Signal pulse duty factor (p.d.f.)		p.d.f. = 1:1	Coding for signal doubling: p.d.f. = 1 : 1 Coding for signal quadrupling: p.d.f. = dependent on the flow speed (impulse frequency) by which the, impulse with remains constant. <b>(Series VE*..., p.d.f. = 1 : 1)</b>

**\*Explanation for series VE...**

If a single pick-up (1 impulse per conveyed tooth gap volume) cannot be used in an application because of the length of its body (115 mm), **a modified double pick-up** of series VE... (**body length 43 mm**) can be used, which operates with only one active carrier frequency oscillator and delivers the signals as a single pick-up.

VHM type list		Single pick-ups		Double pick-ups		
single and double pick-ups		with OV potential not earthed		with OV potential not earthed		
Preferred types		Single channel pick-ups with normal carrier frequency	Single channel pickups with modified carrier frequency	Double channel pick-ups (impulse×2/impulses×4)	Double channel pick-ups modified (impulses×1)	
Available VS-connecting cable <sup>1</sup>	Standard	4-wire connection with U/I-limiting	4-wire connection with U/I-limiting	4-wire connection with U/I-limiting	4-wire connection with U/I-limiting	
	Ex design	2-wire connection with U/I-limiting	2-wire connection with U/I-limiting	2-wire connection with U/I-limiting	2-wire connection with U/I-limiting	
Plug with yellow cable <sup>2</sup> 5/10/15/20 m	Standard	01	VIII-1S00/N	VTII-1S00/N	VDII-1S00/N	VEII-1S00/N
		02	<b>VIII-2S00/N *</b>	<b>VTII-2S00/N *</b>	<b>VDII-2S00/N *</b>	VEII-2S00/N
		03	<b>VIII-2S00/N</b>	<b>VTII-2S00/N</b>	VDII-3S00/N	VEII-3S00/N
Plug with blue cable <sup>2</sup> 5/10/15/20 m	Ex design	01	VILI-1S00/Ex	VTLI-1S00/Ex	VDLI-1S00/Ex	VELI-1S00/Ex
		02	<b>VILI-2S00/Ex *</b>	<b>VTLI-2S00/Ex *</b>	<b>VDLI-2S00/Ex *</b>	VELI-2S00/Ex
		03	<b>VILI-2S00/Ex</b>	<b>VTLI-2S00/Ex</b>	VDLI-3S00/Ex	VELI-3S00/Ex

<sup>1</sup> The connecting are open at one end, but can be delivered with a second plug on request.

<sup>2</sup> Other cable lengths on request. \* **Stock types, other types on request.**

## Signal pick-ups with optical fibre technology for VHM flow meters

Technical Data Part 3	Double pick-ups with fibre optic output VDB...	Fibre optic receiver VUM...
Signal pick-ups per flow meter body	2	Volume impulse/fault signal – <b>Signal voltage U<sub>DC</sub></b> : 9-30 V (depending on the supply voltage and loading of the signal output circuit) <b>Signal current I<sub>DC</sub></b> : max. 10 mA (for supply voltages > 16 V <sub>DC</sub> )
Detection of the direction of flow	No	
<b>Body data</b>		
Dimensions	Ø 78 mm; height 62 mm; overall height with sensor 72 mm	Overall length with optical fibre and plug connector = 98 mm; L = 64 mm; B = 58 mm; H = 37 mm Mounting construction: 2 screws M 4 or installation rail snap-in mounting DIN 50 022
Protection type	IP 54	IP 54
Material	Anodized aluminium; coil holder stainless steel Spul	Aluminium, colour: grey RAL 7001
Weight	438 g	218 g
Medium temperature	-4... +140°F / -20... +60°C	
Ambient temperature	-4... +140°F / -20... +60°C	-13...+140°F / -25... +60°C
Ex approval	According to conformity certificate LCIE 02 ATEX 6136 X	<b>LED indicators:</b> LED green: ready LED red: transmission error
Ex designation	II 1G EEx ia IIC T6...T4	
Associated fibre optic receiver	VUMI-O...	<b>Volume impulse/fault signal</b> – Signal switching polarity: NPN or PNP programmable by 2 coding jumpers
Installation site of the fibre optic receiver	Outside the Ex area (or high voltage area) wall-mounted or in an electrical cabinet; with screw or installation rail mounting DIN 50022 depending on the type.	<b>Volume impulses</b> pulse duty factor (p.d.f.) p.d.f. = 1 : 1
Electrical supply	By internal, sealed lithium battery (use only original parts)	Unregulated power supply with smoothing capacitor
Supply voltage U <sub>DC</sub>	Battery 3,6 V / 16,5 Ah with integrated series resistor for Ex applications	9-30 V
Operating time	2 years (integrated energy saving in stand-by mode)	<b>Supply current I<sub>DC</sub></b> 8 mA
<b>Optical fibre</b>	Silicone-free plastic optical fibre cable with double sheathing	<b>Optical fibre signal input</b> <b>Signal detection:</b> by fibre optic input transistor <b>Signal type:</b> Digital optical signals from double pick-up (flow meter signals; monitor signal in standby, battery status signals)
Stress relief	Aramide fibres	
Outer sheath	Orange polyurethane; flame-resistant	
Outer dimensions	3,5 mm +/- 0,2	
Bending radius	>10 mm short-term; > 50 mm permanent	
Optical fibre connector	Cable gland PG 7, length = 20 mm	
Standard cable lengths	5 / 10 / 15 / 20 m	
Number of signal outputs	1, includes information on the flow meter output impulses and status signals	2, volume impulses (flow meter) fault signals
Signal resolution per conveyed tooth gap volume (measured volume V <sub>m</sub> )	2 impulses (signal doubling)	2 impulses (signal doubling)

## Signal pick-ups with optical fibre technology for VHM flow meters

Technical Data Part 4	Double pick-ups with fibre optic output VDB...	Fibre optic receiver VUM...
Switching frequency f:	3 Hz-1,0 KHz	3 Hz-1,0 KHz
Volume impulses/ fault signals – signal output circuit	<b>Fibre optic output diode:</b> Digital optical signals to the fibre optic receiver (volume sensor signals; monitor signals in stand-by; battery status signals)	One transistor each with series resistor $R = 1,2 \text{ k Ohms}$

## VHM type list optical fibre technology

VHM	Size	Double pick-up with fibre optic output
Standard	01	VDBI – 1K00/N
	02	VDBI – 2K00/N
	03	VDBI – 3K00/N*
Ex design	01	VDBI – 1K00/EX
	02	VDBI – 2K00/EX
	03	VDBI – 3K00/EX*
*Size 03 on request		

Accessories for double pick-up			
VDBI-battery = sealed lithium battery for all double signal pick-ups			
LWL cable = plastic optical fibre cable			
LWL cable	5 m	LWL cable	20 m*
LWL cable	10 m	*other length of optical fibre cable on request	
LWL cable	15 m		

Fibre optic receiver with plug connection		
Body design	Screw mounting	VUMI-OS00/N
	Installation rail snap-in mounting	VUMI-OS01/N

## Performance characteristics of the fault signal output

- ▶ If a low battery state is signalled when the green LED „Ready“ extinguishes and the fault signal output becomes active, operation of the system remains possible for a certain time.
- ▶ The green LED „Ready“ is switched on and the fault signal output is reset automatically when a new battery has been installed in the signal pick-up body.
- ▶ The fault signal output also becomes active on the following transmission errors of the optical fibre, by which the red LED „transmission error“ also lights:
  - A. Interruption of the optical fibre
  - B. Incorrect connection
  - C. Weak optical signal

## Flowmeter Selection

- ▶ The correct choice (interpretation) of the type and size of flowmeter is essential for a trouble-free and safe operation. Due to the large number of different applications and flowmeter models, the technical data in the VSE catalogues are of a general nature.
- Certain characteristics of the devices depend on type, size and measuring range as well as the liquid to be measured. Please consult VSE for an exact choice of flowmeter.

## Barrier amplifier "MK 13-P-Ex 0/24V DC/K15" for VHM flow meters

► VSE provides the barrier amplifier type „MK 13-P-Ex 0/24V DC/K15“ for the application of VHM flow meters in areas with explosion hazards. This operates in conjunction with the pick-up systems of VHM flow meters:

- **VIL-..../Ex** ; **VTL-..../Ex** Single pick-up with plug connection
- **VDL-..../Ex** ; **VEL-..../Ex** Double pick-up with plug connection

► The barrier amplifier has an intrinsically safe control circuit and is equipped with galvanic isolation between the control and output circuits to the supply. It contains a pulse-switching, short-circuit-resistant transistor output and is con-

nected with screw terminals. The amplifier is installed in a plastic housing and is fitted with a snap-in mounting for attachment to an installation rail.

► The barrier amplifier must be installed outside the Ex area in an electrical cabinet or terminal box. The intrinsically safe control lines must be laid and marked according to the design specifications of VDE 0165.

### ► Flow meter VHM...

### ► Barrier amplifier

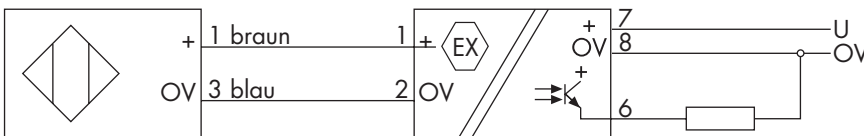

### ► External inductors/ capacitance

[EEx ia] IIB  
2/10/20 mH 5/3,5/3 µF

[EEx ia] IIC  
1/5/10 mH 1,1/0,75/0,65 µF

### ► Technical data of the barrier amplifier MK 13-P-Ex 0/24V DC/K15:

Galvanic isolation of the control and output circuits

**EX approval according to conformity certificate** BVS Nr. 89.C.2010

Control circuit intrinsically safe: EEx ia IIC

Input circuit		Output circuit		Operating values	
Sensor voltage	8,2 V	Signal output	transistor output	Supply voltage	10-30 V DC
Sensor current	< 2,9 mA >3,5 mA		PNP switched	Current consumption	< 20 mA
	(modulated current signal)	Voltage drop	< 2,5 V	Short-circuit current	< 31 mA
Switching threshold	Low = < 2,9 mA	Switching current	< 100 mA		
	High = > 3,5 mA		short-circuit resistant		
Hysteresis	> 0,2 mA	Switching frequency	< 3 kHz		

### LED indicators

Ready	green LED
Switching status	yellow LED

### Body

Dimensions	length 89 mm, width 18 mm, height 71 mm
Material	polycarbonat / ABS
Inflammability class	V-O according to UL 94
Mounting	installation rail (DIN 50022) or G-rail (DIN 50035)
Temperature range	-13°F...+158°F / -25°C...70°C
Protection range	(DIN 40050) IP 20
Weight	70 g

► The two gearwheels of the instrument are set into motion by the volume flow passing through the flow meter. Each tooth of the gearwheel is scanned by a single or double signal pick-up, which is screwed to the flow meter.

When the gearwheel rotates, this signal pick-up generates an electrical output impulse when a tooth of the wheel passes the scanning range.

Each conveyed tooth gap volume corresponds to one electrical output impulse for a single signal pick-up, or 2 or 4 electrical output impulses for a double signal pick-up, depending on the jumper coding.

This volume is enclosed between the tooth gaps of the wheel and the body and is conveyed to the outlet side by the

rotation of the gearwheel.

The volume conveyed out of a tooth gap is designated as the measuring volume  $V_m$ , which determines the significance of the impulses depending on the size of the flow meter.

►  **$V_m$  (l/impulse) = 1/K-factor**

The frequency of the output impulse signal is processed in the associated electronic circuit and is proportional to the speed of rotation of the gearwheel and to the flow velocity. The flow quantity corresponds to the conveyed volume, which is measured by constant electronic counting of the output impulses.



VHM series

## Performance features to further product range

► VSE offers a manufacturing program of flow meters in combination with electronic measuring-, control- and regulation equipment.

We will be pleased to advise you in finding the right solution for your individual project.

► Flow ranges:

0.002 ...700 l/min.  
0.0005...105.7 GPM  
graded unit sizes

► Measuring accuracy:

up to 0,3% of measuring value

► High resolution:

up to 50000 pulses/l

► Viscosity ranges:

1...1000000 cSt.

► Max. pressure:

450 bar / 6500 psi  
higher pressures  
»specials

► Temperature ranges:

-60°C...210°C  
-76°F ...410°F

► EX-protection:

Special flow meters for hazardous areas with Ex approval  
EEx ia IIC T6...T4

► Option:

with fibre optic transmission



VS series



VTR series



Offshore



Process control



Car Industry

► **Special designs on request**

The issue of this catalogue invalidates all specifications in earlier publications. Changes and deviations are reserved by VSE. VSE will not accept liability for printing errors. Reproduction, including excerpts, is only permitted with written permission by VSE. Revision: 08/2006, U.K. exec.



## Worldwide Service

### ▶ **Worldwide service**

Qualified advice  
through longstanding  
cooperation partners

- \_ personal
- \_ competent
- \_ efficient

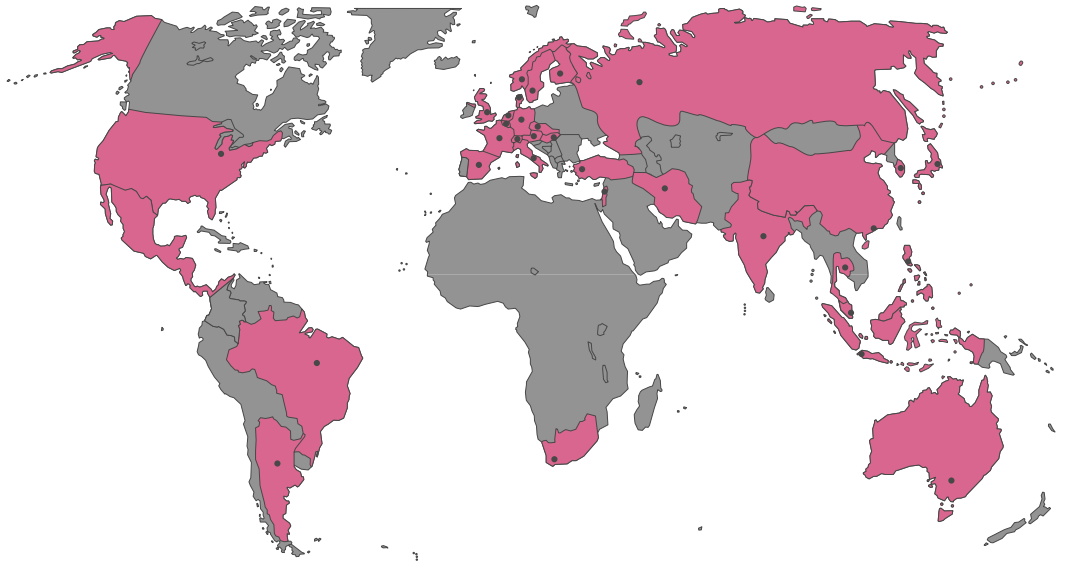

## Products

- ▶ **Precision gear type flowmeters for general industrial applications**
- ▶ **Stainless steel gear type flowmeters for special applications**
- ▶ **Turbine flowmeters**
- ▶ **Standardized and individual electronic readouts**
- ▶ **Electronic devices for special solutions in measurement-, control- and regulation technology**

**VSE**<sub>.flow</sub>

VSE Volumentchnik GmbH  
Hönnestraße 47  
58809 Neuenrade /Germany  
Phone +49 (0)2394/6 16 30  
Fax +49 (0)2394/6 16 33  
info@vse-flow.com  
www.vse-flow.com

distributed by

  
FLUID TECHNOLOGY GROUP

www.e-holding.de